

Tomsed Full Height Turnstiles



Versatile turnstiles for indoor and outdoor security

Our full height turnstile product range consists of several models that all offer excellent security control and can be installed indoors or outdoors depending on their type. Our full height security turnstiles, suitable for controlling unsupervised areas, are available in a wide range of finishes and configurations to suit almost all buildings and environments.

A wide range of models from which to choose

Our full height turnstiles are available in both a 120°, 3-arm configuration or 90°, 4-arm configuration. The 3-arm models offer users more space and comfort, while the 4-arm models minimize the possibility of piggybacking by restricting the user to a smaller segment.

Single or double rotor versions are available, and optional side gates can be used to provide access for wheelchairs, bicycles or handcarts.



Power Door Products

(914) 698-5083

www.PowerDoorProducts.com



THT-100

Fabricated in a variety of durable materials, the THT-100 series provides dependable access control even in unsupervised locations.

Rugged, reliable construction

The THT-100 full height turnstiles are designed for high security areas where emphasis is placed on secure, controlled and unsupervised access. Their rugged construction ensures trouble-free performance and durability.

The heavy duty mechanism can be mechanical with optional self-centering, or electrical with standard self-centering. The electrical turnstiles are available in any combination of fail-lock or fail-safe.

Three rotor sections for 120° of passage space allow greater user comfort. The open construction shield on the THT-100 minimizes claustrophobic effect and increases visual security.

These turnstiles can be fabricated from hot-dipped galvanized steel, powder coated steel, anodized aluminum with stainless steel arms or complete stainless steel.

Space-saving tandem design

The THT-100 tandem full height turnstiles combine the functions of two single rotor turnstiles into one turnstile. The intermeshing of left- and right-hand rotors allows a reduction in overall width from 10 feet (two single rotor turnstiles) to 8 feet with a space saving double gate and no reduction of passage space.

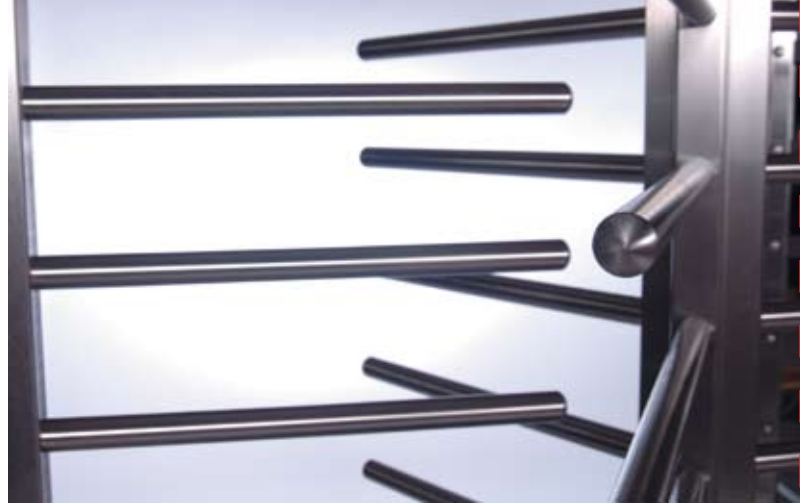

Model	Rotors	# Arms	Aesthetics
THT-100EC (Galvanized Steel)	Single	3 / 4	Basic-medium
THT-100ECP (Powder Coat)	Single	3 / 4	Basic-medium
THT-100EA (Stainless Steel/ Aluminum)	Single	3 / 4	Basic-medium
THT-100ES (Stainless Steel)	Single	3 / 4	Basic-medium
THT-100TC (Tandem, Galvanized Steel)	Dual	3 / 4	Basic-medium
THT-100TCP (Tandem, Powder Coat)	Dual	3 / 4	Basic-medium
THT-100TA (Tandem, Stainless Steel/ Aluminum)	Dual	3 / 4	Basic-medium
THT-100TS (Tandem, Stainless Steel)	Dual	3 / 4	Basic-medium

Standard dimensions and capacity

	A Passage width	B Overall height ¹ electrical / mechanical	C Overall width	Capacity / minute ²
THT-100				
EC, ECP, EA, ES	25 ½"	86" / 84"	60"	15
TC, TCP, TA, TS	25 ½"	86" / 84"	96"	2 x 15

¹Overall height with hydraulic speed control is 89".

²Maximum capacity per minute indicates how many users can pass through in one direction with access control. Capacity per minute in one direction with free rotation is 20ppm.

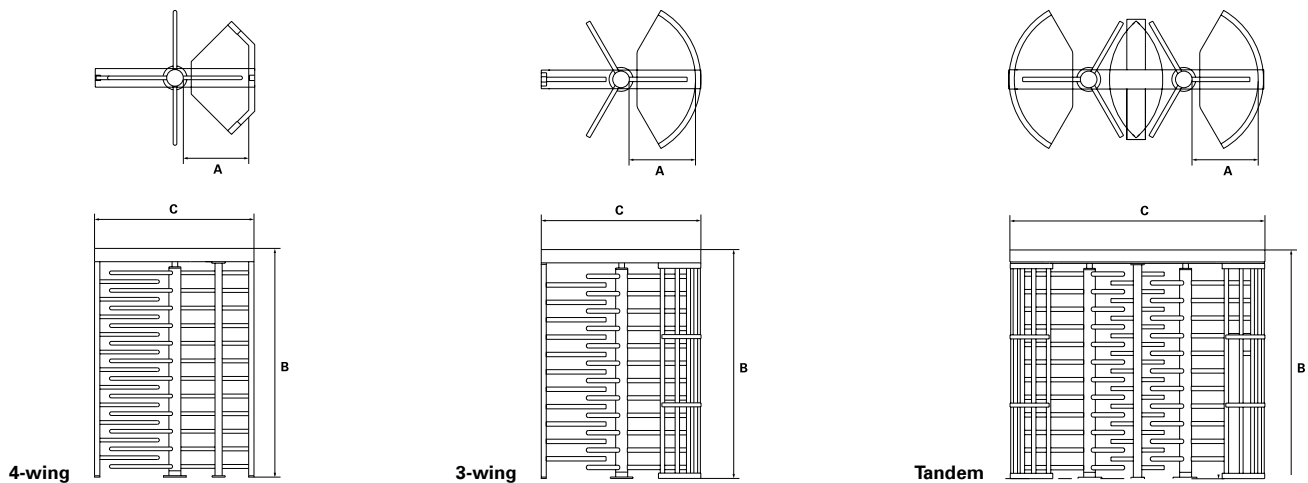

THT-100ASTG

These highly attractive and versatile turnstiles are designed for many years of reliable service. Fabricated from heavy gauge anodized aluminum, they feature extruded arms and clear panel shields.

Reliable, comfortable and stylish

These full height turnstiles are available in several color schemes to provide aesthetic access control to any facility. The THT-100ASTG also is available with dual shields for an enhanced appearance. The THT-100TASTG (Tandem) combines the functions of two single rotor turnstiles into one space-saving turnstile.

Enhanced security with metal detection

The THT-100ASTGMD combines metal detection with the Dual Shield anodized aluminum turnstile. The fully integrated system combines aesthetic appeal with real control for installations demanding accurate and efficient monitoring of persons carrying metal objects.

There are two key-operated modes of operation:

1. The first allows users free passage through the turnstile unless a metal object is detected. If the metal detector is initiated, the turnstile locks and prevents passage until the violation is resolved by security personnel.
2. The second mode integrates an access control system into the turnstile that only allows one authorized user at a time to enter. If an alarm condition occurs, the access control reader is shunted and the turnstile remains locked, barring entry until the violation is investigated and cleared.



Model	Rotors	# Arms	Aesthetics
THT-100ASTG	Single	3	Medium-high
THT-100ASTGMD (Metal Detection)	Single	3	Medium-high
THT-100TASTG (Tandem)	Dual	3	Medium-high

Standard dimensions and capacity

	A Passage width	B Overall height ¹ electrical / mechanical	C Overall width	Capacity / minute ²
THT-100ASTG				
ASTG	25 ½"	86" / 84"	60"	15
ASTGMD	25 ½"	88" / --	60"	15
TASTG	25 ½"	86" / 84"	96"	2 x 15

¹Overall height with hydraulic speed control is 89".

²Maximum capacity per minute indicates how many users can pass through in one direction with access control. Capacity per minute in one direction with free rotation is 20ppm.

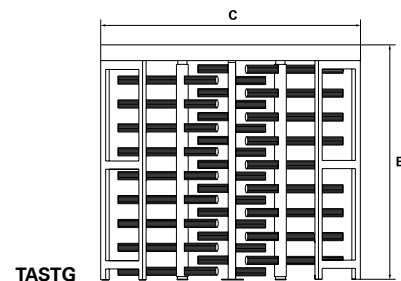
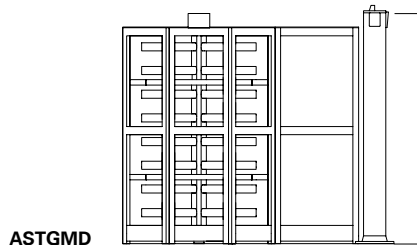
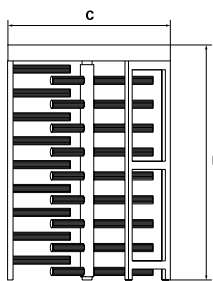
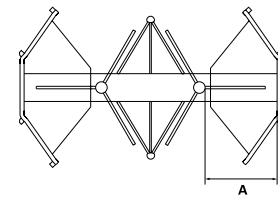
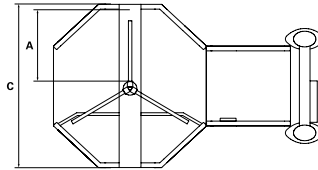
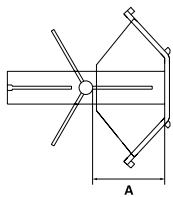

ASTG

ASTGMD

TASTG

Transparent

Our transparent full height turnstiles offer the ideal solution for applications requiring structural integrity and impenetrability along with aesthetic appeal. The clear, see-through design achieves a clean, finished look.

Security meets design

The THT-100EL utilizes clear arms and a curved polycarbonate shield assembly. A stainless steel square canopy provides the clean, finished look of a revolving door.

The THT-100TL also combines clear arms and curved polycarbonate shield assembly, but includes the functions of a dual rotor turnstile. A stainless steel middle barrier prevents unauthorized access through the midsection of the turnstile.

Enhanced aesthetic appeal

In lieu of many individual arms, the THT-100CSTG features three large clear panels per rotor section. The shield assembly also incorporates clear panels to enhance the aesthetic appeal.

<i>Model</i>	<i>Rotors</i>	<i># Arms</i>	<i>Aesthetics</i>
THT-100EL	Single	3 / 4	High
THT-100CSTG	Single	3	High
THT-100TL	Dual	3 / 4	High



Standard dimensions and capacity

	A Passage width	B Overall height ¹ electrical only	C Overall width	Capacity / minute ²
Transparent				
THT-100EL	24 ½"	89"	60"	15
THT-100CSTG	25 ½"	89"	60"	15
THT-100TL	24 ½"	89"	96"	2 x 15

¹Overall height includes hydraulic speed control.

²Maximum capacity per minute indicates how many users can pass through in one direction with access control. Capacity per minute in one direction with free rotation is 20ppm.

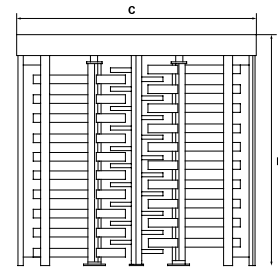
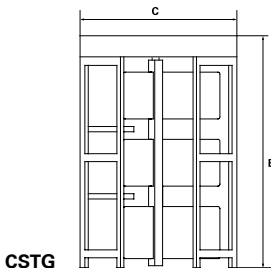
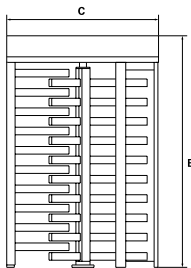
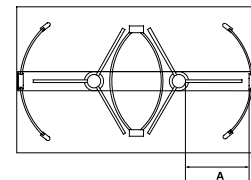
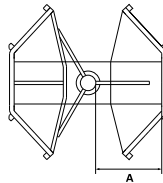
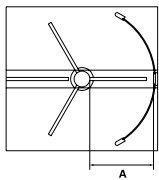

EL

CSTG

TL

THT-100MT (Mantrap)

The THT-100MT (Mantrap) turnstile offers the highest level of security through a unique two-stage entry process. The turnstile's design ensures access is restricted to authorized users only.

Two-stage entry for maximum security

Boon Edam's unique mantrap full height security turnstile is specifically designed for very high security applications requiring positive identification through a biometric device. Use of the mantrap turnstile involves a two-stage entry process with independent controls for each stage:

1. At the initial stage, the user is required to present a valid form of identification. The turnstile will rotate 90-degrees and allow access into the second quadrant.
2. Next, a second device (typically a biometric reader) verifies the individual's identity before completing the final 90-degree rotation to allow access into the secure area.

Electrically controlled exiting through traditional access or with the use of a biometric control device also is available.



Model	Rotors	# Arms	Aesthetics
THT-100MT	Single	4	Basic-medium

Standard dimensions and capacity

	A Passage width	B Overall height electrical only	C Overall width	Capacity / minute ¹
Mantrap				
THT-100MT	24 1/2"	86"	60"	10

¹Maximum capacity per minute indicates how many users can pass through in one direction with access control. Capacity per minute in one direction with free rotation is 20ppm.

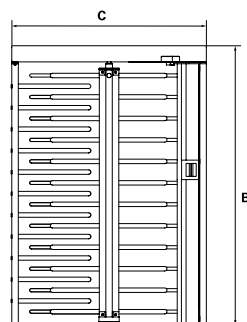
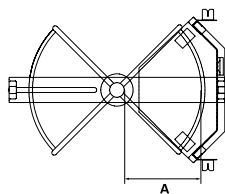

Mantrap

Standards & options

	THT-100		THT-100ASTG		Transparent	
	Std	Opt	Std	Opt	Std	Opt
Mechanical and/or electrical turnstiles						
Second curved shield enclosure		•		•		•
Heel protectors on the lower arms		•		•		•
Four arm sections		•		N/A		• ¹
Powder coating in the desired color		•		N/A		•
Anodized aluminium in the color of choice		N/A		•		•
Key to initiate manual operation		•		•		•
Stainless steel canopy		•		•		• ²
Electrical turnstiles						
Indication lamps (red/green) in the ceiling of the turnstile (for each monitored direction)		•		•		•
Time-out relay (for each monitored direction). The turnstile locks automatically if the pre-set transit time is exceeded and no one has passed through the door		•		•		•
Pulse relay for connection of an authorization system (for each monitored direction)		•		•		•
Rotation detection sensor per direction to create a transit signal for the authorization system		•		•		•
External push button (for each monitored direction)		•		•		•
Hydraulic speed control		•		•		•
Card reader mounting plates		•		•		•
Out-of-use lock		•		•		N/A

¹Not available on THT-100CSTG models.

²Optional on THT-100CSTG models.

Technical specifications

Power supply ¹	110 VAC (220 VAC optional), 50/60 Hz Converted to 24 Volt
Power consumption ¹	Less than 1 amp at 110 VAC
Working temperature	5°F to 110°F
Weight (approx):	
EC, ECP, ES..... 700 lbs	TASTG..... 1650 lbs
TC, TCP, TS..... 1300 lbs	EL..... 1000 lbs
EA 650 lbs	CSTG 1000 lbs
TA..... 1200 lbs	TL..... 1900 lbs
ASTG 800 lbs	MT..... 850 lbs
ASTGMD 900 lbs	
Connection	The electrical full height turnstile communicates with most authorization systems using potential free contacts.

¹Only for electrical models

High quality

At Boon Edam, we take quality seriously; the quality of the materials we use, the quality of our employees and the quality of our partners. As with all Boon Edam products, our Full Height Turnstiles are manufactured to the highest standards, including all local, state and national codes.



Power Door Products

(914) 698-5083

www.PowerDoorProducts.com

